



# ArenaVision MVF403

## MVF403 MHN-SA2000W/956 A6 SI

ARENAVISION - MASTER MHN-SA - 2000 W

ArenaVision MVF403 takes sports floodlighting to the highest level, offering very high light output, optical efficiency, ease of installation, reliability and flexibility. It is ideal for indoor sports halls (1000 W version) as well as many outdoor sports and other lighting applications. The integrated system of oval optics and compact double-ended MHN-LA 1000W or MHN-SA HO 2000W lamps ensures outstanding system efficiency and low glare. A built-in reflector skirt reduces spill light and glare even further. The MHN-SA HO 2000W/956 and MHN-LA 1000W/956 lamps meet the highest international CTV requirements. With the MHN-LA 1000W/842 lamp, the natural colour rendering and comfortable atmosphere are well suited to TV and filming as well as other floodlighting applications. Hot re-strike versions are available for all lamp types, enabling immediate restoration of lighting after power supply failure. The (optional) flicker-free version of ArenaVision MVF403 MHN-LA 1000W is designed to ensure that the flicker effect is fully eliminated in order to guarantee perfect images filmed with super-slow-motion cameras at sports events. The flicker-free version of ArenaVision MVF403 comes equipped with a special electronic igniter, which works in combination with Philips' electronic ballast GearUnits (ECM330), to be ordered separately.

### Product data

General Information		Protection class IEC	
Number of light sources	1 [ 1 pc]	Protection class IEC	Safety class I (I)
Lamp family code	MHN-SA [ MASTER MHN-SA]	CE mark	CE mark
Lamp power	2000 W	ENEC mark	ENEC mark
Lamp colour code	956 daylight	Optic type outdoor	Beam category A6
Kombipack	Lamp(s) included	Aiming memory	-
Gear	-	Product family code	MVF403 [ ARENAVISION]
Optical cover/lens type	DOWN [ Front-glass downlighting version]		

# ArenaVision MVF403

## Operating and Electrical

Lamp supply voltage	400 V [ 400]
Input Voltage	380 to 415 V
Ignitor	SI [ Series]

## Mechanical and Housing

Dimensions (height x width x depth)	NaN x NaN x NaN mm (NaN x NaN x NaN in)
-------------------------------------	---

## Approval and Application

Ingress protection code	IP65 [ Dust penetration-protected, jet-proof]
Mech. impact protection code	IK08 [ 5 J vandal-protected]

## Initial Performance (IEC Compliant)

Lamp colour temperature	5600 K
-------------------------	--------

## Application Conditions

Ambient temperature range	-30 to +35 °C
---------------------------	---------------

## Product Data

Full product code	871829106918800
Order product name	MVF403 MHN-SA2000W/956 A6 SI
EAN/UPC – product	8718291069188
Order code	910925748812
SAP numerator – quantity per pack	1
Numerator – packs per outer box	1
SAP material	910925748812
SAP net weight (piece)	14.500 kg

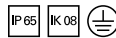

## Dimensional drawing

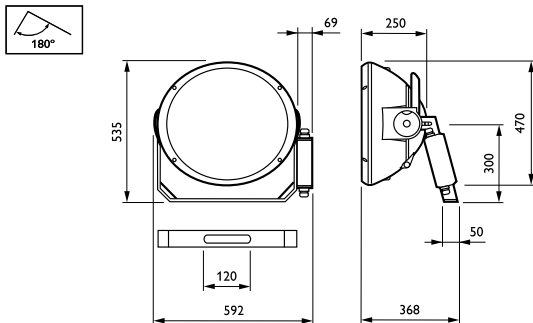

ArenaVision MVF403/MVF404

